

Quality
Die buttons
EDM die button blanks
Locking Devices

DIE BUTTONS



Global leader in
providing fabrication
and stamping solutions

www.daytonprogress.com



DIE BUTTONS

• AD_	headless ISO 8977	1.1
• AN_	taper relief with press-in lead	1.2
• AH_	headed ISO 8977	1.3
• AHU	EDM headed die button blanks	1.4
• AHE	EDM headed die button blanks with counterbore relief	1.5
• ADU	EDM die button blanks	1.6
• ADE	EDM headed die button blanks with counterbore relief	1.7
• DR_	Precision headed die button with taper relief	1.8
• DN_	Precision headless die button with taper relief	1.9

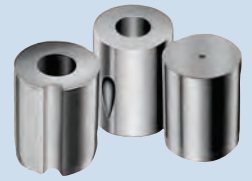

MISCELLANEOUS

• Locking Devices	2.1
• Classified Shapes	2.2

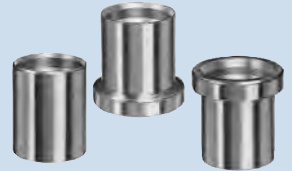

HEADLESS DIE BUTTONS TYPE AD_

Steel	HRC
A2 (HWS)	60-63
M2 (HSS)	60-63

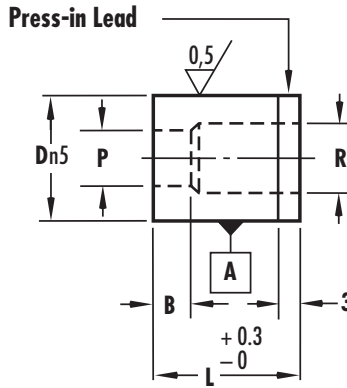
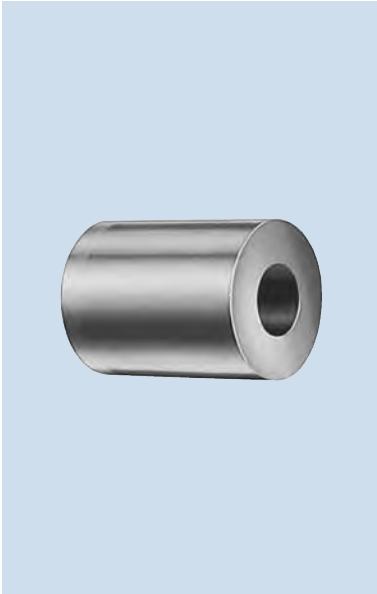

headless ISO 8977,

**AD Matrixes conform to NAAMS standard for Straight relief die buttons. For Diameters 32-100 add XDT-j6 to the end of the catalog number to receive NAAMS standard j6 tolerance for large diameters.

Steel: A2 (Standard) and M2 – please specify when ordering

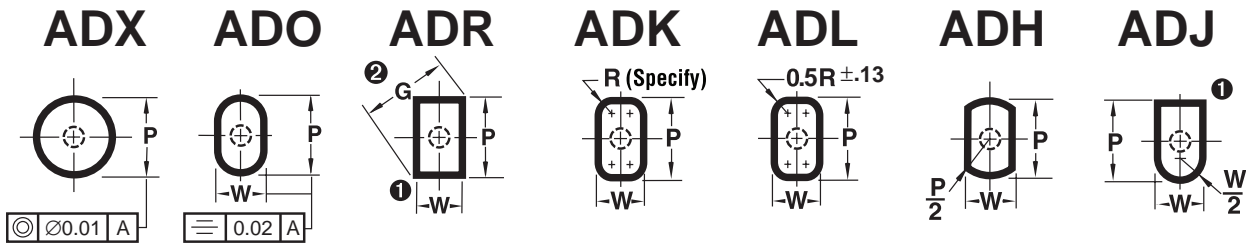

1 Sharp corners are typical. To assure proper clearance, Dayton will provide standard broken corners if die button is ordered with punch to eliminate interference with die button fillet when total clearance is 0.08 or less.

2 Check your P&W dimensions to be sure the diagonal G does not exceed the max. shown.

$$G = \sqrt{P^2 + W^2}$$

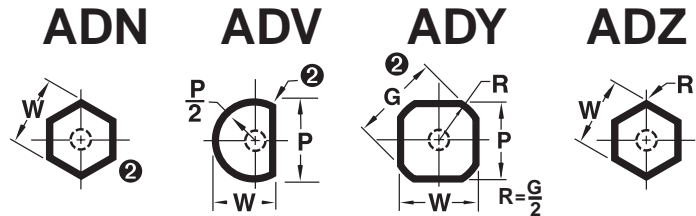

Body Ø D	Std. S	B Alt. A	Alt. B	Type & D	Range (Standard) P	Type & D	Shape		R	L							
							Min. W	Max. P/G		20	22	25	28	30	32	32	35
08	4	–	–	ADX 08	1.50-2.40	–	–	–	3.5	•	•	•	•	•	•	•	•
	4	–	–	ADX 08	2.41-3.00	–	–	–	4.0	•	•	•	•	•	•	•	•
	4	8	–	ADX 08	3.01-3.20	–	–	–	4.0	•	•	•	•	•	•	•	•
10	4	–	–	ADX 10	1.50-2.40	A_10	–	–	3.5	•	•	•	•	•	•	•	•
	4	–	–	ADX 10	2.41-3.00	A_10	–	–	4.0	•	•	•	•	•	•	•	•
	4	8	–	ADX 10	3.01-3.20	A_10	1.20-3.20	–	4.0	•	•	•	•	•	•	•	•
	4	8	–	ADX 10	3.21-5.00	A_10	1.20-5.00	–	6.0	•	•	•	•	•	•	•	•

Body Ø D	Point Length L ₁			Type & D	Range (Standard) P	Type & D	Shape		Max. R	L						
	Std.	Alt.	Alt.				Min.	Max.								
	S	A	B				W	P/G		20	22	25	28	30	32	35
13	5	—	—	ADX13	1.50-2.40	AD_13	—	3.5	•	•	•	•	•	•	•	
	5	—	—	ADX13	2.41-3.00	AD_13	—	4.0	•	•	•	•	•	•	•	
	5	8	—	ADX13	3.01-3.20	AD_13	—	4.0	•	•	•	•	•	•	•	
	5	8	—	ADX13	3.21-5.00	AD_13	2.00-5.00	6.0	•	•	•	•	•	•	•	
	5	8	—	ADX13	5.01-7.20	AD_13	2.00-7.20	8.0	•	•	•	•	•	•	•	
16	5	8	—	ADX16	5.00-7.20	AD_16	2.40-7.20	8.0	•	•	•	•	•	•	•	
	5	8	—	ADX16	7.21-8.80	AD_16	2.40-8.80	9.5	•	•	•	•	•	•	•	
20	5	12	20	ADX20	7.00-8.80	AD_20	3.20-8.80	9.5	•	•	•	•	•	•	•	
	5	12	20	ADX20	8.81-11.00	AD_20	3.20-11.00	12.0	•	•	•	•	•	•	•	
22	6	12	20	ADX22	9.00-14.00	AD_22	4.00-14.00	15.0	•	•	•	•	•	•	•	
25	6	12	20	ADX25	11.00-14.00	AD_25	4.80-14.00	15.0	•	•	•	•	•	•	•	
	6	12	20	ADX25	14.01-16.50	AD_25	4.80-16.50	17.5	•	•	•	•	•	•	•	
32	6	12	20	ADX32	13.00-16.50	AD_32	5.50-16.50	17.5	•	•	•	•	•	•	•	
	6	12	20	ADX32	16.51-20.00	AD_32	5.50-20.00	21.0	•	•	•	•	•	•	•	
38	8	12	20	ADX38	16.00-20.00	AD_38	6.40-20.00	21.0	•	•	•	•	•	•	•	
	8	12	20	ADX38	20.01-26.00	AD_38	6.40-26.00	27.0	•	•	•	•	•	•	•	
40	8	12	20	ADX40	16.00-20.00	AD_40	6.40-20.00	21.0	•	•	•	•	•	•	•	
	8	12	20	ADX40	20.01-26.00	AD_40	6.40-26.00	27.0	•	•	•	•	•	•	•	
45	8	12	20	ADX45	19.00-26.00	AD_45	8.00-26.00	27.0	•	•	•	•	•	•	•	
	8	12	20	ADX16	26.01-35.00	AD_45	8.00-35.00	36.0	•	•	•	•	•	•	•	
50	8	12	20	ADX50	22.00-26.00	AD_50	—	27.0	•	•	•	•	•	•	•	
	8	12	20	ADX50	26.01-35.00	AD_50	9.00-35.00	36.0	•	•	•	•	•	•	•	
	8	12	20	ADX50	35.01-40.00	AD_50	9.00-40.00	41.0	•	•	•	•	•	•	•	
56	8	12	20	ADX56	25.00-35.00	AD_56	10.00-35.00	36.0	•	•	•	•	•	•	•	
	8	12	20	ADX56	35.01-40.00	AD_56	10.00-40.00	41.0	•	•	•	•	•	•	•	
	8	12	20	ADX56	40.01-45.00	AD_56	40.00-45.00	46.0	•	•	•	•	•	•	•	
63	8	12	20	ADX63	28.00-35.00	AD_63	—	36.0	•	•	•	•	•	•	•	
	8	12	20	ADX63	35.01-40.00	AD_63	11.00-40.00	41.0	•	•	•	•	•	•	•	
	8	12	20	ADX63	40.01-45.00	AD_63	11.00-45.00	46.0	•	•	•	•	•	•	•	
	8	12	20	ADX63	45.01-50.00	AD_63	11.00-50.00	51.0	•	•	•	•	•	•	•	
71	8	12	20	ADX71	31.00-40.00	AD_71	12.00-40.00	41.0	•	•	•	•	•	•	•	
	8	12	20	ADX71	40.01-45.00	AD_71	12.00-45.00	46.0	•	•	•	•	•	•	•	
	8	12	20	ADX71	45.01-50.00	AD_71	12.00-50.00	51.0	•	•	•	•	•	•	•	
	8	12	20	ADX71	50.01-56.00	AD_71	12.00-56.00	57.0	•	•	•	•	•	•	•	
76	8	12	20	ADX76	39.00-45.00	AD_76	15.00-45.00	46.0	•	•	•	•	•	•	•	
	8	12	20	ADX76	45.01-50.00	AD_76	15.00-50.00	51.0	•	•	•	•	•	•	•	
	8	12	20	ADX76	50.01-56.00	AD_76	15.00-56.00	57.0	•	•	•	•	•	•	•	
	8	12	20	ADX76	56.01-60.00	AD_76	15.00-60.00	61.0	•	•	•	•	•	•	•	
85	8	12	20	ADX85	43.00-50.00	AD_85	21.00-50.00	51.0	•	•	•	•	•	•	•	
	8	12	20	ADX85	50.01-56.00	AD_85	21.00-56.00	57.0	•	•	•	•	•	•	•	
	8	12	20	ADX85	56.01-60.00	AD_85	21.00-60.00	61.0	•	•	•	•	•	•	•	
	8	12	20	ADX85	60.01-66.00	AD_85	21.00-66.00	67.0	•	•	•	•	•	•	•	
90	8	12	20	ADX90	45.00-50.00	AD_90	25.00-50.00	51.0	•	•	•	•	•	•	•	
	8	12	20	ADX90	50.01-56.00	AD_90	25.00-56.00	57.0	•	•	•	•	•	•	•	
	8	12	20	ADX90	56.01-60.00	AD_90	25.00-60.00	61.0	•	•	•	•	•	•	•	
	8	12	20	ADX90	60.01-66.00	AD_90	25.00-66.00	67.0	•	•	•	•	•	•	•	
	8	12	20	ADX90	66.01-70.00	AD_90	25.00-70.00	71.0	•	•	•	•	•	•	•	
100	8	12	20	ADX100	50.00-56.00	AD_100	33.00-56.00	57.0	•	•	•	•	•	•	•	
	8	12	20	ADX100	56.01-60.00	AD_100	33.00-60.00	61.0	•	•	•	•	•	•	•	
	8	12	20	ADX100	60.01-66.00	AD_100	33.00-66.00	67.0	•	•	•	•	•	•	•	
	8	12	20	ADX100	66.01-70.00	AD_100	33.00-70.00	71.0	•	•	•	•	•	•	•	
	8	12	20	ADX100	70.01-78.00	AD_100	33.00-78.00	79.0	•	•	•	•	•	•	•	

Standard Alterations for headless die buttons Type AD_

Standard alterations are the ranges beyond those sizes listed in the catalogue which can be manufactured for a slight additional charge.

D	AD_			
	Min. P	Min. W	Max. P/G	R
10	1.5*	1.2	5.5	6.0
13	1.5*	1.2	7.5	8.0
16	3.0	2.0	9.0	9.5
20	5.0	2.4	11.5	12.0
22	7.0	3.2	14.5	15.0
25	9.0	4.0	17.0	17.5
32	11.0	4.8	20.5	21.0
38	13.0	5.5	26.5	27.0
40	13.0	5.5	26.5	27.0
45	16.0	6.4	35.0	36.0
50	19.0	8.0	40.0	41.0
56	22.0	9.0	45.0	46.0
63	25.0	10.0	50.0	51.0
71	28.0	11.0	56.0	57.0
76	31.0	12.0	60.0	61.0
85	39.0	15.0	66.0	67.0
90	43.0	21.0	70.0	71.0
100	45.0	25.0	78.0	79.0

* 3.00 Min. P at 8 mm Land Length

XP, XW

P or W dimensions smaller than standard

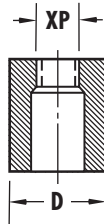

LOCKING DEVICES

For die buttons Type AD_ see page 2.1.1.

XL,

Overall Length shortened
Doesn't shorten B length.
Minimum overall length = 13.

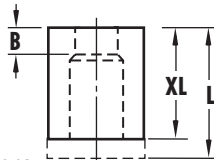

LL

Precision Overall Length
Same as XL except overall length is held to ± 0.02 .

XSC

Slug Control
Eliminates slug pulling.

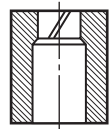

How to order:

Slug Control

ADX	13 S25	P7.0	A2	XSC	MM0.3	CS5
Type	D L	P	Steel	Alt. Code	Material Thickness	Clear per Side (%)

Please specify when ordering thickness and clearance (% per side).

XBL

Straight through Land

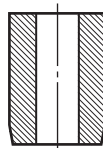

XAL

10° Angled Lead on AD_
The Angle provides clearance for steps left by CNC machining.

Standard on AN_ die buttons.

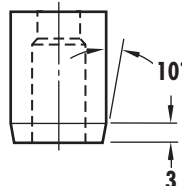

How to order:

Specify: Quantity
Type
Body Diameter
& Length Codes
Steel
P or P&W Dimensions
Standard Alteration

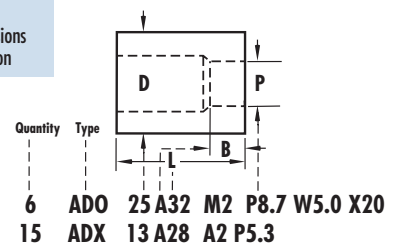

TAPER RELIEF DIE BUTTONS TYPE AN_

Steel	HRC
A2 (HWS)	60-63

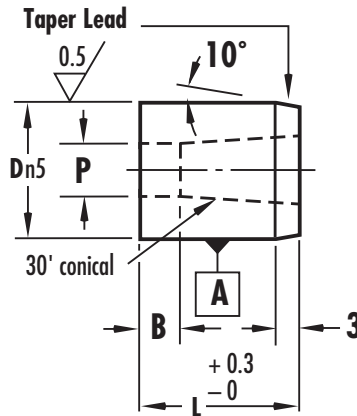
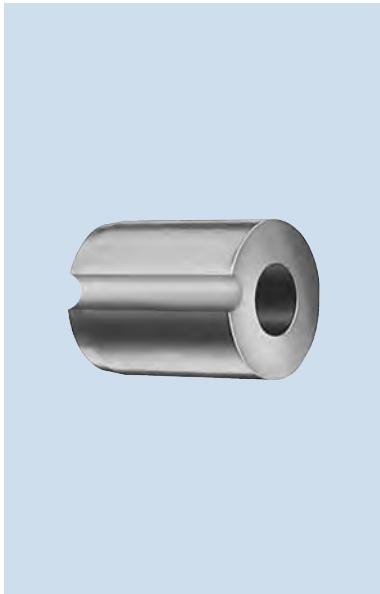

Shown above with Locking Device X43, for Ø6 Dowel (NAAMS™ standard).

with press-in lead

*AN Matrixes conform to NAAMS standard for Tapered relief die buttons. For Diameters 32-100 add XDT-j6 to the end of the catalog number to receive NAAMS standard j6 tolerance for large diameters.

Steel: A2 – please specify when ordering

ANX

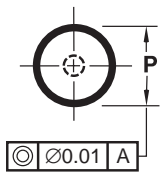

ANO

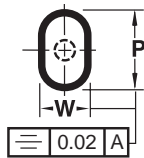

ANR

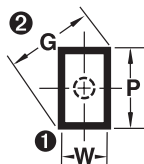

ANK

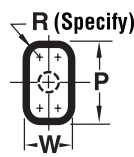

ANL

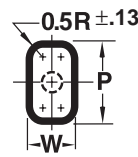

ANH

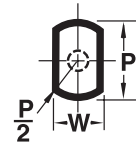

ANJ

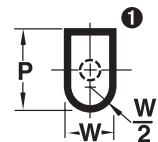

1 Sharp corners are typical. To assure proper clearance, Dayton will provide standard broken corners if die button is ordered with punch to eliminate interference with die button fillet when total clearance is 0.08 or less.

2 Check your P&W dimensions to be sure the diagonal G does not exceed the max. shown.

$$G = \sqrt{P^2 + W^2}$$

ANN



ANV

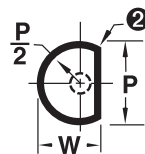

ANY

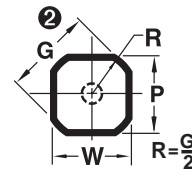

ANZ

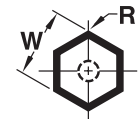

Body Ø D	B			Type & D	Range (Standard) P	Type & D	Shape		L											
	Std.	Alt.	Alt.				Min.	Max.												
	S	A	B				W	P/G	13	16	20	22	25	28	30	32	35	40		
10	4	5	3	ANX10	1.60- 6.80	AN_10	1.30-	6.80	•	•	•	•	•	•	•	•	•	•	•	•
13	5	8	3	ANX13	3.00- 8.80	AN_13	1.90-	8.80	•	•	•	•	•	•	•	•	•	•	•	•
16	5	8	3	ANX16	7.40-10.80	AN_16	1.90-	10.80			•	•	•	•	•	•	•	•	•	•
20	5	10	3	ANX20	9.50-13.60	AN_20	1.90-	13.60			•	•	•	•	•	•	•	•	•	•
22	6	10	3	ANX22	10.50-15.00	AN_22	1.90-	15.00			•	•	•	•	•	•	•	•	•	•
25	6	10	3	ANX25	12.00-17.00	AN_25	1.90-	17.00			•	•	•	•	•	•	•	•	•	•
32	6	12	3	ANX32	16.00-22.00	AN_32	1.90-	22.00			•	•	•	•	•	•	•	•	•	•
38	8	12	3	ANX38	18.00-27.00	AN_38	1.90-	27.00			•	•	•	•	•	•	•	•	•	•

Body Ø D	B			Type & D	Range (Standard) P	Type & D	Shape		L												
	Std.	Alt.	Alt.				Min.	Max.													
	S	A	B				W	P/G	13	16	20	22	25	28	30	32	35	40			
40	8	12	3	ANX40	18.00-27.00	AN_40	1.90-27.00				•	•	•	•	•	•	•	•	•		
45	8	12	3	ANX45	18.00-35.00	AN_45	2.40-35.00				•	•	•	•	•	•	•	•	•	•	•
50	8	12	3	ANX50	18.00-40.00	AN_50	4.00-40.00				•	•	•	•	•	•	•	•	•	•	•
56	8	12	3	ANX56	18.00-45.00	AN_56	4.00-45.00				•	•	•	•	•	•	•	•	•	•	•
63	8	12	3	ANX63	18.00-50.00	AN_63	4.00-50.00				•	•	•	•	•	•	•	•	•	•	•
71	8	12	3	ANX71	18.00-56.00	AN_71	4.00-56.00				•	•	•	•	•	•	•	•	•	•	•
76	8	12	3	ANX76	25.00-60.00	AN_76	5.60-60.00				•	•	•	•	•	•	•	•	•	•	•
85	8	12	3	ANX85	25.00-66.00	AN_85	5.60-66.00				•	•	•	•	•	•	•	•	•	•	•
90	8	12	3	ANX90	32.00-70.00	AN_90	5.60-70.00				•	•	•	•	•	•	•	•	•	•	•
100	8	12	3	ANX100	32.00-78.00	AN_100	5.60-78.00				•	•	•	•	•	•	•	•	•	•	•

Standard Alterations for AN_ die buttons

Standard alterations are the ranges beyond those sizes listed in the catalogue which can be manufactured for a slight additional charge.

**XP,
XW** P or W dimensions larger or smaller than standard

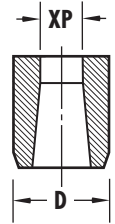

XL, Overall Length shortened
Doesn't shorten B length.
Minimum overall length = 13.

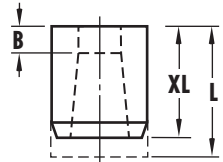

LL Precision Overall Length
Same as XL except overall length is held to ± 0.02.

XSC Slug Control
Eliminates slug pulling.

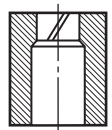

How to order:
Slug Control

ANX	25 S32	P12.0	A2	XSC	MM0.3	CS5
Type	D L	P	Steel	Alt. Code	Material Thickness	Clear per Side (%)

Please specify when ordering thickness and clearance (% per side).

XBL Straight through Land

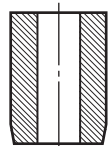

How to order:

ANO 25 A32 A2 P8.7 W5.0 X43

LOCKING DEVICES

For die buttons Type AN_ see page 2.1.1.

HEADED DIE BUTTONS TYPE AH_

Steel	HRC
A2 (HWS)	60-63
M2 (HSS)	60-63

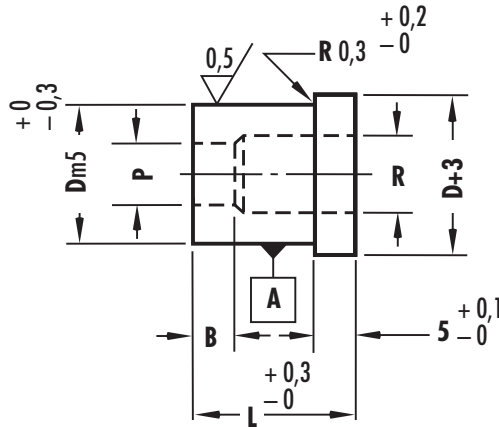
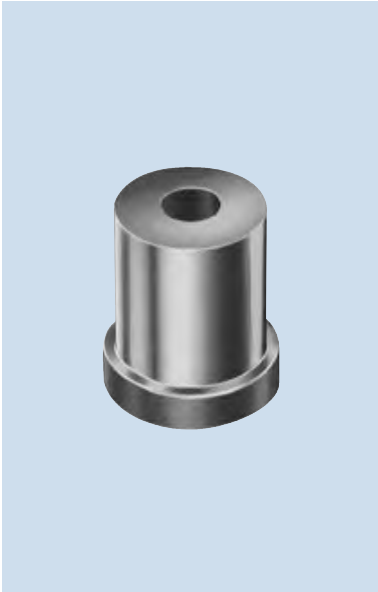

headed die buttons ISO 8977

Steel: A2 (Standard) and M2 – please specify when ordering

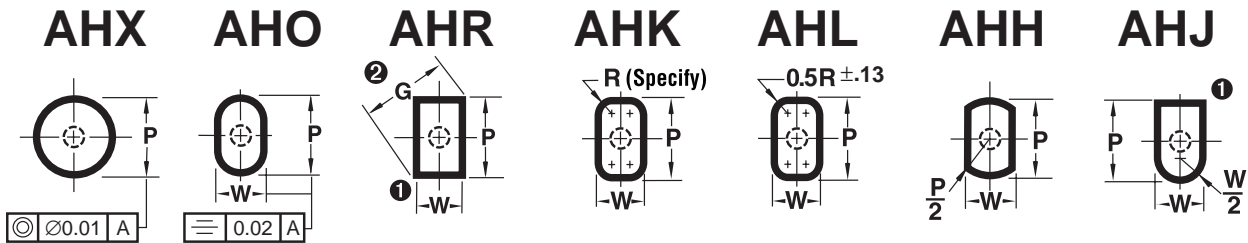

1 Sharp corners are typical. To assure proper clearance, Dayton will provide standard broken corners if the button is ordered with punch to eliminate interference with the button fillet when total clearance is 0.08 or less.

2 Check your P&W dimensions to be sure the diagonal G does not exceed the max. shown.

$$G = \sqrt{P^2 + W^2}$$

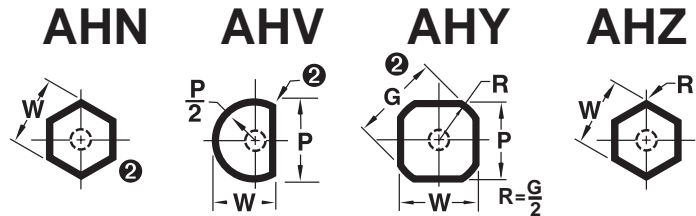

Body Ø D	B			Type & D	Range (Standard) P	Type & D	Shape			L							
	Std. S	Alt. A	Alt. B				Min. W	Max. P/G	R	20	22	25	28	30	32	32	35
08	4	-	-	AHX 08	1.50-2.40	-	-	-	3.5	•	•	•	•	•	•	•	•
	4	-	-	AHX 08	2.41-3.00	-	-	-	4.0	•	•	•	•	•	•	•	•
	4	8	-	AHX 08	3.01-3.20	-	-	-	4.0	•	•	•	•	•	•	•	•
10	4	-	-	AHX 10	1.50-2.40	A__10	-	-	3.5	•	•	•	•	•	•	•	•
	4	-	-	AHX 10	2.41-3.00	A__10	-	-	4.0	•	•	•	•	•	•	•	•
	4	8	-	AHX 10	3.01-3.20	A__10	1.20-3.20	-	4.0	•	•	•	•	•	•	•	•
	4	8	-	AHX 10	3.21-5.00	A__10	1.20-5.00	-	6.0	•	•	•	•	•	•	•	•

Body Ø D	Std. S	B Alt. A	Alt. B	Type & D	Range (Standard) P	Type & D	Shape		R	L							
							Min. W	Max. P/G		20	22	25	28	30	32	32	35
13	5	—	—	AHX 13	1.50-2.40	A__13	—	—	3.5	•	•	•	•	•	•	•	•
	5	—	—	AHX 13	2.41-3.00	A__13	—	—	4.0	•	•	•	•	•	•	•	•
	5	8	—	AHX 13	3.01-3.20	A__13	—	—	4.0	•	•	•	•	•	•	•	•
	5	8	—	AHX 13	3.21-5.00	A__13	2.00-5.00		6.0	•	•	•	•	•	•	•	•
	5	8	—	AHX 13	5.01-7.20	A__13	2.00-7.20		8.0	•	•	•	•	•	•	•	•
16	5	8	—	AHX 16	5.00-7.20	A__16	2.40-7.20		8.0	•	•	•	•	•	•	•	•
	5	8	—	AHX 16	7.21-8.80	A__16	2.40-8.80		9.5	•	•	•	•	•	•	•	•
20	5	12	20	AHX 20	7.00-8.80	A__20	3.20-8.80		9.5	•	•	•	•	•	•	•	•
	5	12	20	AHX 20	8.81-11.00	A__20	3.20-11.00		12.0	•	•	•	•	•	•	•	•
22	6	12	20	AHX 22	9.00-14.00	A__22	4.00-14.00		15.0	•	•	•	•	•	•	•	•
25	6	12	20	AHX 25	11.00-14.00	A__25	4.80-14.00		15.0	•	•	•	•	•	•	•	•
	6	12	20	AHX 25	14.01-16.50	A__25	4.80-16.50		17.5	•	•	•	•	•	•	•	•
32	6	12	20	AHX 32	13.00-16.50	A__32	5.50-16.50		17.5	•	•	•	•	•	•	•	•
	6	12	20	AHX 32	16.51-20.00	A__32	5.50-20.00		21.0	•	•	•	•	•	•	•	•
38	8	12	20	AHX 38	16.00-20.00	A__38	6.40-20.00		21.0	•	•	•	•	•	•	•	•
	8	12	20	AHX 38	20.01-26.00	A__38	6.40-26.00		27.0	•	•	•	•	•	•	•	•
40	8	12	20	AHX 40	16.00-20.00	A__40	6.40-20.00		21.0	•	•	•	•	•	•	•	•
	8	12	20	AHX 40	20.01-26.00	A__40	6.40-26.00		27.0	•	•	•	•	•	•	•	•
45	8	12	20	AHX 45	19.00-26.00	AH_45	8.00-26.00		27.0	•	•	•	•	•	•	•	•
	8	12	20	AHX 45	26.01-35.00	AH_45	8.00-35.00		36.0	•	•	•	•	•	•	•	•
50	8	12	20	AHX 50	22.00-26.00	AH_50	—	—	27.0	•	•	•	•	•	•	•	•
	8	12	20	AHX 50	26.01-35.00	AH_50	9.00-35.00		36.0	•	•	•	•	•	•	•	•
	8	12	20	AHX 50	35.01-40.00	AH_50	9.00-40.00		41.0	•	•	•	•	•	•	•	•
56	8	12	20	AHX 56	25.00-35.00	AH_56	10.00-35.00		36.0	•	•	•	•	•	•	•	•
	8	12	20	AHX 56	35.01-40.00	AH_56	10.00-40.00		41.0	•	•	•	•	•	•	•	•
	8	12	20	AHX 56	40.01-45.00	AH_56	10.00-45.00		46.0	•	•	•	•	•	•	•	•
63	8	12	20	AHX 63	28.00-35.00	AH_63	—	—	36.0	•	•	•	•	•	•	•	•
	8	12	20	AHX 63	35.01-40.00	AH_63	11.00-40.00		41.0	•	•	•	•	•	•	•	•
	8	12	20	AHX 63	40.01-45.00	AH_63	11.00-45.00		46.0	•	•	•	•	•	•	•	•
	8	12	20	AHX 63	45.01-50.00	AH_63	11.00-50.00		51.0	•	•	•	•	•	•	•	•
71	8	12	20	AHX 71	31.00-40.00	AH_71	12.00-40.00		41.0	•	•	•	•	•	•	•	•
	8	12	20	AHX 71	40.01-45.00	AH_71	12.00-45.00		46.0	•	•	•	•	•	•	•	•
	8	12	20	AHX 71	45.01-50.00	AH_71	12.00-50.00		51.0	•	•	•	•	•	•	•	•
	8	12	20	AHX 71	50.01-56.00	AH_71	12.00-56.00		57.0	•	•	•	•	•	•	•	•
76	8	12	20	AHX 76	39.00-45.00	AH_76	15.00-45.00		46.0	•	•	•	•	•	•	•	•
	8	12	20	AHX 76	45.01-50.00	AH_76	15.00-50.00		51.0	•	•	•	•	•	•	•	•
	8	12	20	AHX 76	50.01-56.00	AH_76	15.00-56.00		57.0	•	•	•	•	•	•	•	•
	8	12	20	AHX 76	56.01-60.00	AH_76	15.00-60.00		61.0	•	•	•	•	•	•	•	•
85	8	12	20	AHX 85	43.00-50.00	AH_85	21.00-50.00		51.0	•	•	•	•	•	•	•	•
	8	12	20	AHX 85	50.01-56.00	AH_85	21.00-56.00		57.0	•	•	•	•	•	•	•	•
	8	12	20	AHX 85	56.01-60.00	AH_85	21.00-60.00		61.0	•	•	•	•	•	•	•	•
	8	12	20	AHX 85	60.01-66.00	AH_85	21.00-66.00		67.0	•	•	•	•	•	•	•	•
90	8	12	20	AHX 90	45.00-50.00	AH_90	25.00-50.00		51.0	•	•	•	•	•	•	•	•
	8	12	20	AHX 90	50.01-56.00	AH_90	25.00-56.00		57.0	•	•	•	•	•	•	•	•
	8	12	20	AHX 90	56.01-60.00	AH_90	25.00-60.00		61.0	•	•	•	•	•	•	•	•
	8	12	20	AHX 90	60.01-66.00	AH_90	25.00-66.00		67.0	•	•	•	•	•	•	•	•
	8	12	20	AHX 90	66.01-70.00	AH_90	25.00-70.00		71.0	•	•	•	•	•	•	•	•
100	8	12	20	AHX 100	50.00-56.00	AH_100	33.00-56.00		57.0	•	•	•	•	•	•	•	•
	8	12	20	AHX 100	56.01-60.00	AH_100	33.00-60.00		61.0	•	•	•	•	•	•	•	•
	8	12	20	AHX 100	60.01-66.00	AH_100	33.00-66.00		67.0	•	•	•	•	•	•	•	•
	8	12	20	AHX 100	66.01-70.00	AH_100	33.00-70.00		71.0	•	•	•	•	•	•	•	•
	8	12	20	AHX 100	70.01-78.00	AH_100	33.00-78.00		79.0	•	•	•	•	•	•	•	•

Standard Alterations for AH₋ die buttons

Standard alterations are the ranges beyond those sizes listed in the catalogue which can be manufactured for a slight additional charge.

D	Min. P	Min. W	Max. P/G	Max. R
10	1.5*	1.2	5.5	6.0
13	1.5*	1.2	7.5	8.0
16	3.0	2.0	9.0	9.5
20	5.0	2.4	11.5	12.0
22	7.0	3.2	14.5	15.0
25	9.0	4.0	17.0	17.5
32	11.0	4.8	20.5	21.0
38	13.0	5.5	26.5	27.0
40	13.0	5.5	26.5	27.0

*P min 3.00 at 8mm Land Length

XP, XW

P or W dimensions smaller than standard

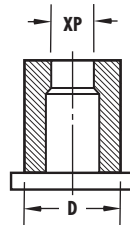

LOCKING DEVICES

For die buttons Type AH₋ see page 2.1.1.

XL,

XL Overall Length Shortened
On AH₋ material is removed from top.
Shortens B length.
Minimum overall length = 13.

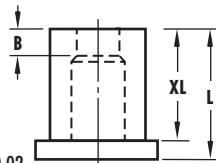

LL

Precision Overall Length
Same as XL except overall length is held to ± 0.02 .

XSC

Slug Control
Eliminates slug pulling.

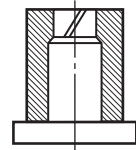

How to order:

Slug Control

AHX	13 S25	P7.0	M2	XSC	MM0.3	CS5
Type	D L	P	Steel	Alt. Code	Material Thickness	Clear per Side (%)

Please specify when ordering thickness and clearance (% per side).

XT, TT

Head thinner than standard
Stock removal from head end which shortens overall length.

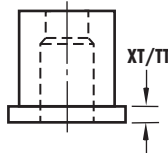

Precision Head Thickness
Same as XT except Head thickness tolerance is held to ± 0.01 .

XH

Reduced Head Diameter
Minimum head diameter equals $D + 0.00 - 0.03$.

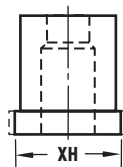

How to order:

Specify: Quantity
Type
Body Diameter & Length Codes
Steel
P or P&W Dimensions
Standard Alteration

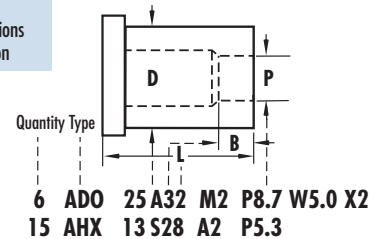

EDM HEADED DIE BUTTON BLANKS TYPE AHU

Steel	HRC
A2 (HWS)	60-63
M2 (HSS)	60-63

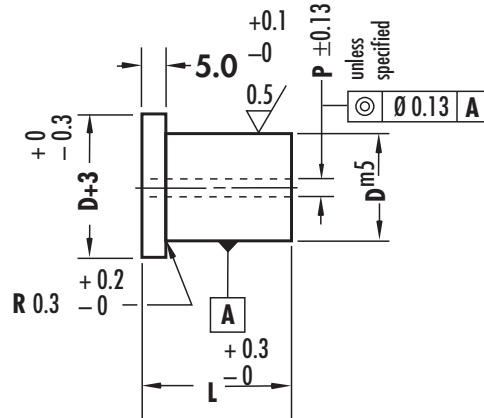

Steel: **A2 or M2 – please specify when ordering**

Type	Body Ø D	P	L						
			20	22	25	28	30	32	35
AHU	8.0	0.8	•	•	•	•	•	•	•
	10.0	0.8	•	•	•	•	•	•	•
	13.0	1.6	•	•	•	•	•	•	•
	16.0	1.6	•	•	•	•	•	•	•
	20.0	1.6	•	•	•	•	•	•	•
	22.0	1.6	•	•	•	•	•	•	•
	25.0	1.6	•	•	•	•	•	•	•
	32.0	1.6	•	•	•	•	•	•	•
	38.0	1.6	•	•	•	•	•	•	•
	40.0	1.6	•	•	•	•	•	•	•

How to order:

Specify: Quantity **2**
 Type **AHU**
 Body Diameter & Length Codes **32 25**
 Steel **A2**

For the fastest delivery use the hole (P) dimensions given in the chart.
 If a larger hole is desired simply specify „XP“ and give the dimension.

EDM HEADED DIE BUTTON BLANKS WITH COUNTER-BORE RELIEF

Steel	HRC
A2 (HWS)	60-63
M2 (HSS)	60-63

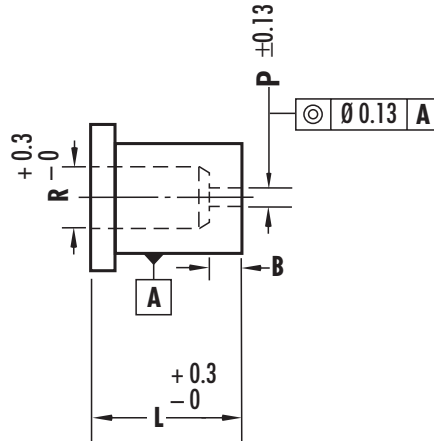

Steel: **A2 or M2 – please specify when ordering**

Type	Body Ø D	P	Point Length B				R	L						
			Std. S	Alt. A	Alt. B									
						20		22	25	28	30	32	35	
AHE	8.0	0.8	–	–	–	–	•	•	•	•	•	•	•	
AHE	10.0	0.8	4	8	–	6.0	•	•	•	•	•	•	•	
AHE	13.0	1.6	5	8	–	8.0	•	•	•	•	•	•	•	
AHE	16.0	1.6	5	8	–	9.5	•	•	•	•	•	•	•	
AHE	20.0	1.6	5	12	20	12.0	•	•	•	•	•	•	•	
AHE	22.0	1.6	6	12	20	15.0	•	•	•	•	•	•	•	
AHE	25.0	1.6	6	12	20	17.5	•	•	•	•	•	•	•	
AHE	32.0	1.6	6	12	20	21.0	•	•	•	•	•	•	•	
AHE	38.0	1.6	8	12	20	27.0	•	•	•	•	•	•	•	
AHE	40.0	1.6	8	12	20	27.0	•	•	•	•	•	•	•	

How to order:

Specify: Quantity

Type

Body Diameter & Length Codes

Steel

2

AHE

32 25

A2

For the fastest delivery use the hole (P) dimensions given in the chart. If a larger hole is desired simply specify „XP“ and give the dimension.

EDM DIE BUTTON BLANKS TYPE ADU

Steel	HRC
A2 (HWS)	60-63
M2 (HSS)	60-63

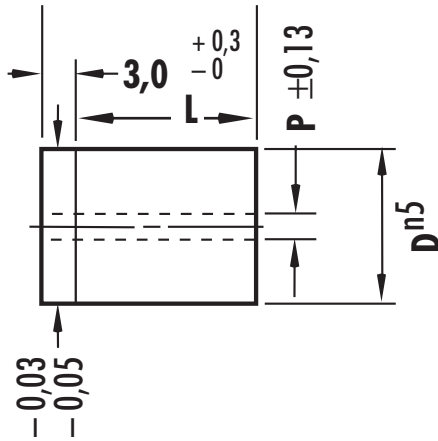

Steel: A2 or M2 – please specify when ordering

Type	Body Ø D	P	L							
			20	22	25	28	30	32	35	40
ADU	8.0	0.8	•	•	•	•	•	•	•	•
ADU	10.0	0.8	•	•	•	•	•	•	•	•
ADU	13.0	1.6	•	•	•	•	•	•	•	•
ADU	16.0	1.6	•	•	•	•	•	•	•	•
ADU	20.0	1.6	•	•	•	•	•	•	•	•
ADU	22.0	1.6	•	•	•	•	•	•	•	•
ADU	25.0	1.6	•	•	•	•	•	•	•	•
ADU	32.0	1.6	•	•	•	•	•	•	•	•
ADU	38.0	1.6	•	•	•	•	•	•	•	•
ADU	40.0	1.6	•	•	•	•	•	•	•	•
ADU	45.0	3.2	•	•	•	•	•	•	•	•
ADU	50.0	3.2	•	•	•	•	•	•	•	•
ADU	56.0	3.2	•	•	•	•	•	•	•	•
ADU	63.0	3.2	•	•	•	•	•	•	•	•
ADU	71.0	3.2	•	•	•	•	•	•	•	•
ADU	76.0	3.2	•	•	•	•	•	•	•	•
ADU	85.0	3.2	•	•	•	•	•	•	•	•
ADU	90.0	3.2	•	•	•	•	•	•	•	•
ADU	100.00	3.2	•	•	•	•	•	•	•	•

How to order:

Specify: Quantity **2**
 Type **ADU**
 Body Diameter & Length Codes **40 32**
 Steel **A2**

For the fastest delivery use the hole (P) dimensions given in the chart. If a larger hole is desired simply specify „XP“ and give the dimension.

EDM DIE BUTTON BLANKS WITH COUNTER-BORE RELIEF

Steel	HRC
A2 (HWS)	60-63
M2 (HSS)	60-63

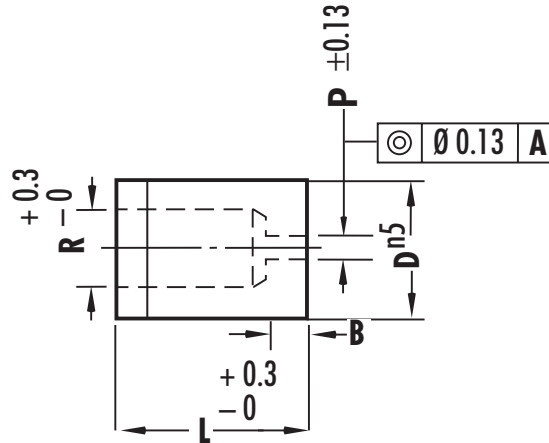

Steel: A2 or M2 – please specify when ordering

Type	Body Ø D	P	Point Length B			R	L								
			Std. S	Alt. A	Alt. B		20	22	25	28	30	32	35	40	
ADE	8.0	0.8	–	–	–	–	•	•	•	•	•	•	•	•	
	10.0	0.8	4	8	–	6.0	•	•	•	•	•	•	•	•	
	13.0	1.6	5	8	–	8.0	•	•	•	•	•	•	•	•	
	16.0	1.6	5	8	–	9.5	•	•	•	•	•	•	•	•	
	20.0	1.6	5	12	20	12.0	•	•	•	•	•	•	•	•	
	22.0	1.6	6	12	20	15.0	•	•	•	•	•	•	•	•	
	25.0	1.6	6	12	20	17.5	•	•	•	•	•	•	•	•	
	32.0	1.6	6	12	20	21.0	•	•	•	•	•	•	•	•	
	38.0	1.6	8	12	20	27.0	•	•	•	•	•	•	•	•	
	40.0	1.6	8	12	20	27.0	•	•	•	•	•	•	•	•	
	45.0	3.2	8	12	20	36.0		•	•	•	•	•	•	•	•
	50.0	3.2	8	12	20	41.0		•	•	•	•	•	•	•	•
	56.0	3.2	8	12	20	46.0		•	•	•	•	•	•	•	•
	63.0	3.2	8	12	20	51.0		•	•	•	•	•	•	•	•
	71.0	3.2	8	12	20	57.0		•	•	•	•	•	•	•	•
	76.0	3.2	8	12	20	61.0		•	•	•	•	•	•	•	•
	85.0	3.2	8	12	20	67.0		•	•	•	•	•	•	•	•
	90.0	3.2	8	12	20	71.0		•	•	•	•	•	•	•	•
	100.00	3.2	8	12	20	79.0		•	•	•	•	•	•	•	•

How to order:

Specify: Quantity **2**
 Type **ADE**
 Body Diameter & Length Codes **40 32**
 Steel **A2**

For the fastest delivery use the hole (P) dimensions given in the chart. If a larger hole is desired simply specify „XP“ and give the dimension.



PRECISION HEADED DIE BUTTONS WITH TAPER RELIEF

Steel	HRC
A2 (HWS)	60-63
M2 (HSS)	60-63
PS	63-65

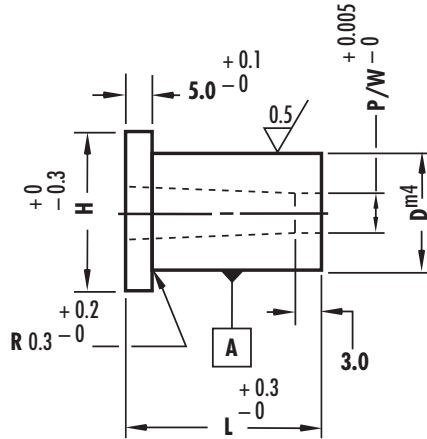
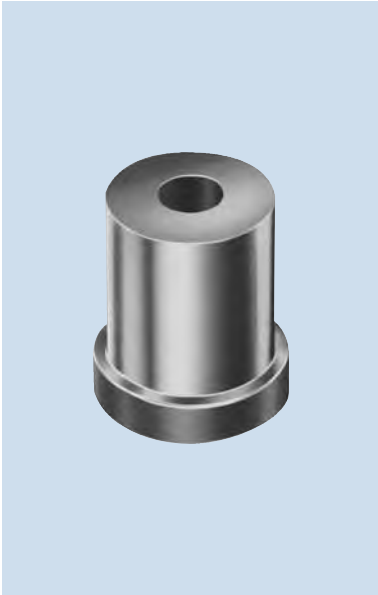

Precision headed die buttons

Steel: A2, M2 or PS – please specify when ordering

DRX

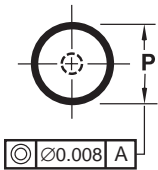

DRO

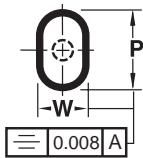

DRR

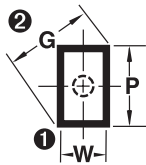

DRK

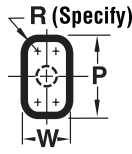

DRL

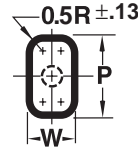

DRH

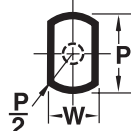

DRJ

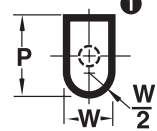

1 Sharp corners are typical. To assure proper clearance, Dayton will provide standard broken corners if die button is ordered with punch to eliminate interference with die button fillet when total clearance is 0.08 or less.

2 Check your P&W dimensions to be sure the diagonal G does not exceed the max. shown.

$$G = \sqrt{P^2 + W^2}$$

DRN



DRV

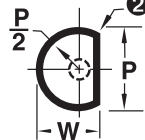

DRY

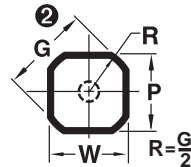

DRZ



Body Ø D	H	Round Range P	Shape		L									
			Min. W	Max. P/G	13.0	16.0	20.0	22.0	25.0	28.0	30.0	32.0	35.0	
5.0	8.0	1.60- 3.20	1.30- 3.20											
6.0	9.0	1.60- 3.90	1.30- 3.90											
8.0	11.0	2.40- 5.40	1.30- 5.40		13	16	20	22	25	28	30	32		
10.0	13.0	3.20- 6.80	1.30- 6.80											35
13.0	16.0	5.40- 8.80	1.90- 8.80											
16.0	19.0	7.40-10.80	1.90-10.80											
20.0	23.0	9.50-13.60	1.90-13.60											
25.0	28.0	12.00-17.00	1.90-17.00											
32.0	35.0	16.00-22.00	1.90-22.00											
38.0	41.0	18.00-27.00	1.90-27.00											
40.0	43.0	18.00-27.00	1.90-27.00				20	22	25	28	30	32	35	

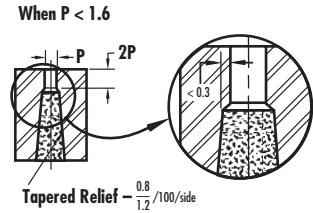
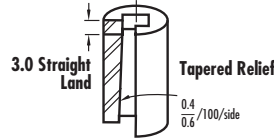
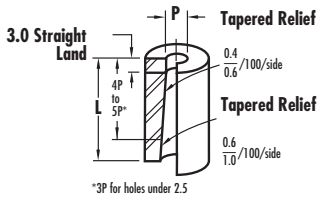

Standard Alterations for DR_ die buttons

Standard alterations are the ranges beyond those sizes listed in the catalogue which can be manufactured for a slight additional charge.

XP,

P & W larger than standard

XW

Body Code Ø	5.0	6.0	8.0	10.0	13.0	16.0	20.0	25.0	32.0	38.0	40.0
Max. P/G	3.5	4.5	6.5	8.5	11.5	14.5	18.5	23.5	30.5	30.40	32.00

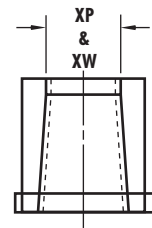

XB

Land Length XB shorter or longer than standard

Hole Range	0.800-1.600	1.601-2.400	2.401-4.000	4.001-6.000	6.001-8.000	8.001-10.000	10.001 over
Max. XB	3.2	5.0	6.0	8.0	9.5	11.0	13.0

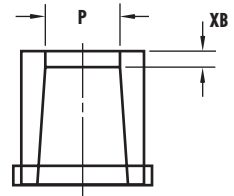

XD

Reduced Body Dia.

Head Diameter does not change with body reduction.

Body Code Ø	5.0	6.0	8.0	10.0	13.0	16.0	20.0	25.0	32.0	38.0	40.0
Min. XD	3.500	5.000	6.500	8.500	11.500	14.500	18.500	23.000	30.000	36.000	38.000
Max. P/G	0.72D	0.75D	0.77D	0.80D	0.80D	0.80D	0.80D	0.80D	0.80D	0.80D	0.80D

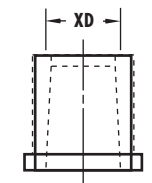

XL

Overall Length shortened

Minimum overall length

Headless= 6 Headed= 6 + T

LL

Precision Overall Length

Same as XL except overall length is held to ± 0.02.

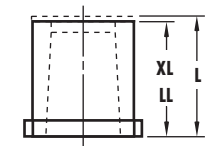

XT

Head thinner than standard

Stock removal from head end which shortens overall length.

TT

Precision Head Thickness

Same as XT except head thickness is held to ± 0.01.

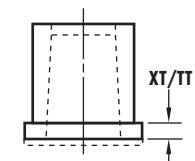

XH

Reduced Head Diameter
 Minimum Head Diameter equals
 $D + 0.00 - 0.03$.

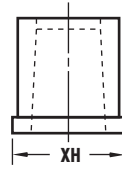
**XN**

DayTride® a unique wear resistant surface treatment for M2 and PS only.

XNT**DAYTiN®**

Titanium Nitride coating for
 extra wear. For M2 and PS only.

LOCKING DEVICES

For die buttons Type DR_ see page 2.1.2.

SHORTENED DIE BUTTON

To minimize slug jamming in the die button, the land length should be shortened for stock thicknesses less than 0.80. The shorter land lengths are available at no extra charge but must be specified.

Stock Thickness T	0.10-0.30	0.30-0.50	0.50-0.80	0.80-up
Recommended Land Length XB	0.8	1.6	2.4	3.0

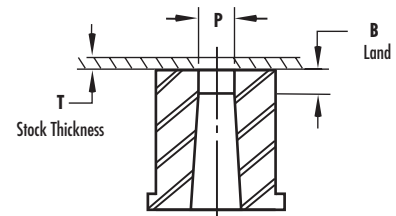

Example: T= 0.40 DNX 05 25 P2.600 M2 XB1.6

How to order:

Specify: Quantity
 Type
 Shank & Length Codes
 Steel
 P or P&W Dimensions
 Standard Alteration

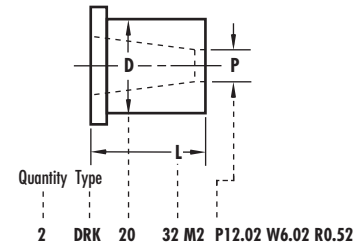

PRECISION HEADLESS DIE BUTTON WITH COUNTER-BORE RELIEF

Steel	HRC
A2 (HWS)	60-63
M2 (HSS)	60-63
PS	63-65

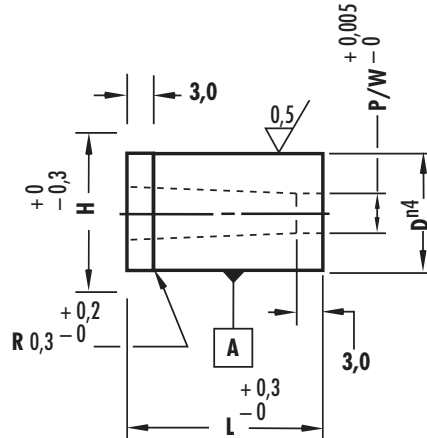
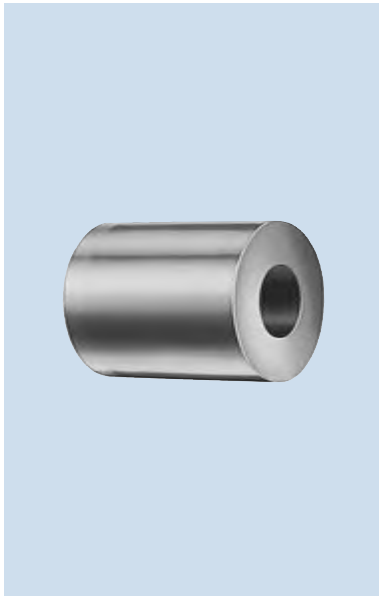

Precision headless die buttons
D 45.0 through 71.0 only available as A2 and M2

Steel: A2, M2 and PS – please specify when ordering

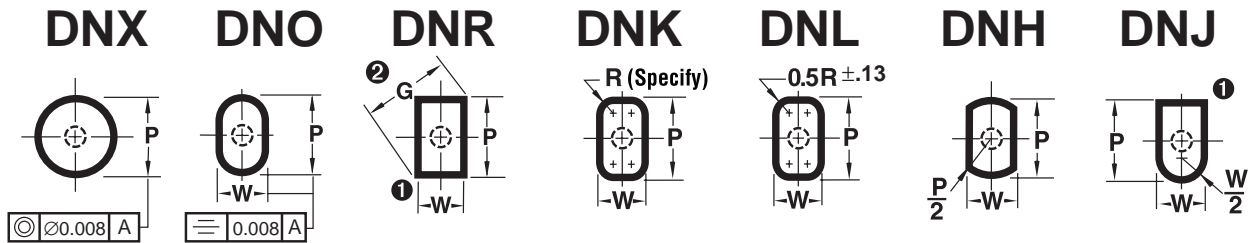

1 Sharp corners are typical. To assure proper clearance, Dayton will provide standard broken corners if die button is ordered with punch to eliminate interference with the button fillet when total clearance is 0.08 or less.

2 Check your P&W dimensions to be sure the diagonal G does not exceed the max. shown.

$$G = \sqrt{P^2 + W^2}$$

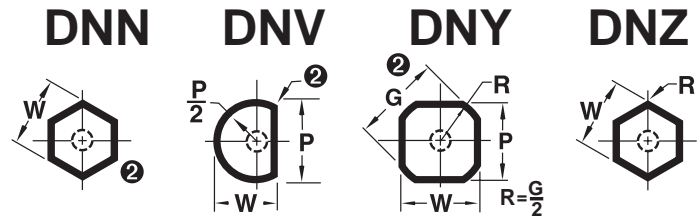

Body Ø D	H	Round Range P	Shape		L											
			Min. W	Max. P/G	13.0	16.0	20.0	22.0	25.0	28.0	30.0	32.0	35.0	40.0		
5.0	8.0	1.60-3.20	1.30	3.20												
6.0	9.0	1.60-3.90	1.30	3.90												
8.0	11.0	2.40-5.40	1.30	5.40	13	16	20	22	25	28	30	32				
10.0	13.0	3.20-6.80	1.30	6.80										35		
13.0	16.0	5.40-8.80	1.90	8.80												
16.0	19.0	7.40-10.80	1.90	10.80												
20.0	23.0	9.50-13.60	1.90	13.60												
25.0	28.0	12.00-17.00	1.90	17.00												
32.0	35.0	16.00-22.00	1.90	22.00												
38.0	41.0	18.00-27.00	1.90	27.00												
40.0	43.0	18.00-27.00	1.90	27.00												

Body Ø D	H	Round Range P	Shape		L										
			Min. W	Max. P/G	13,0	16,0	20,0	22,0	25,0	28,0	30,0	32,0	35,0	40,0	
45.0		18.00-35.00	4.80-35.00												
50.0		18.00-40.00	4.80-40.00												
56.0		18.00-45.00	4.80-45.00						22	25	28	30	32	35	40
63.0		18.00-50.00	4.80-50.00												
71.0		18.00-56.00	4.80-56.00												

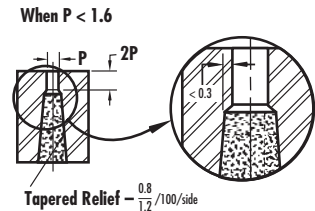
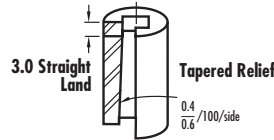
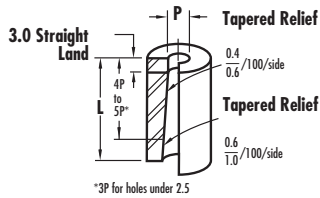

Standard Alterations for DN_ die buttons

Standard alterations are the ranges beyond those sizes listed in the catalogue which can be manufactured for a slight additional charge.

XP,

P & W Dimensions larger than standard

XW

Body Code Ø	5.0	6.0	8.0	10.0	13.0	16.0	20.0	25.0	32.0	38.0	40.0
Max. P/G	3.5	4.5	6.5	8.5	11.5	14.5	18.5	23.5	30.5	30.40	32.00

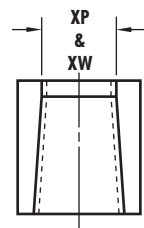

XB

Land Length XB shorter or longer than standard

Hole Range	0.800-1.600	1.601-2.400	2.401-4.000	4.001-6.000	6.001-8.000	8.001-10.000	10.001 over
Max. XB	3.2	5.0	6.0	8.0	9.5	11.0	13.0

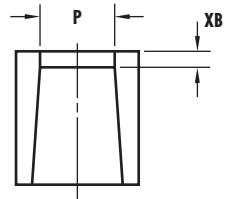

XD

Reduced Body Dia.

Head Diameter does not change with body reduction.

Body Code Ø	5.0	6.0	8.0	10.0	13.0	16.0	20.0	25.0	32.0	38.0	40.0
Min. XD	3.500	5.000	6.500	8.500	11.500	14.500	18.500	23.000	30.000	36.000	38.000
Max. P/G	0.72D	0.75D	0.77D	0.80D	0.80D	0.80D	0.80D	0.80D	0.80D	0.80D	0.80D

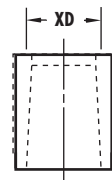

XL

Overall Length shortened

Minimum overall length

Headless= 6 Headed= 6 + T

LL

Precision Overall Length

Same as XL except overall length is held to ± 0.02.

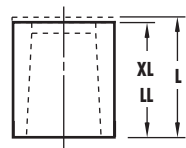

LOCKING DEVICES

For die buttons Type DN_ see page 2.1.2.

SHORTENED DIE BUTTON

To minimize slug jamming in the die button, the land length should be shortened for stock thicknesses less than 0.80. The shorter land lengths are available at no extra charge but must be specified.

Stock Thickness T	0.10-0.30	0.30-0.50	0.50-0.80	0.80-up
Recommended Land Length XB	0.8	1.6	2.4	3.0

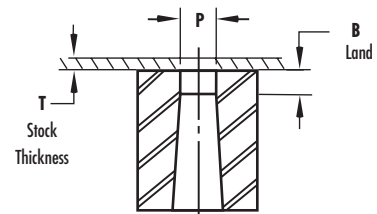

Example: T= 0.40 DNX 05 25 P2.600 M2 XB1.6

How to order:

- Specify: Quantity
- Type
- Shank & Length Codes
- Steel
- P or P&W Dimensions
- Standard Alteration

A diagram of a die button with dimensions: 'D' for diameter, 'P' for land length, and 'L' for length. Below the diagram is a table with two rows of data.

Quantity	Type					
2	DNX	50	25 M2	P37.92	M2 XD49.99	
5	DNX	13	35 A2	P8.00	W2.15 XB2.00	

LOCKING DEVICES FOR DIE BUTTONS TYPE AD_, AN_ AND AH_

Definitions:

Standard Location is at 0°.

Alternate Location is 90°, 180° or 270°.

Alternate Locations are available at no additional charge.

Custom Location

is any angle other than: 0°, 90°, 180° or 270°.

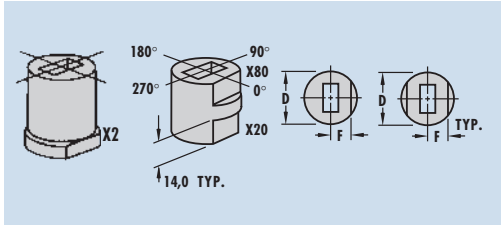

Flats

Locking Devices: Die button	Single Flats X2, X20 and X80			Single Flats X5, X50 and X90		
	X2 Bottom	X20 Bottom	X80 Top	X5 Bottom	X50 Bottom	X90 Top

How to order:

X2 – 90°

X5 – 135°

Locking Devices: Die button	Double Flats X3		Double Flats X6	
	X3 Bottom		X6 Bottom	

How to order:

X3 – 90°

X6 – 135°

Second Flat is always parallel to the first flat.

Die button

Body Ø	08	10	13	16	20	22	25	32	38	40
F	3.5	4.0	5.5	7.0	8.5	9.5	11.0	14.0	17.0	18.0
Body Ø	45	50	56	63	71	76	85	90	100	
F	20.5	23.0	26.0	29.5	33.5	35.5	40.0	42.5	47.5	

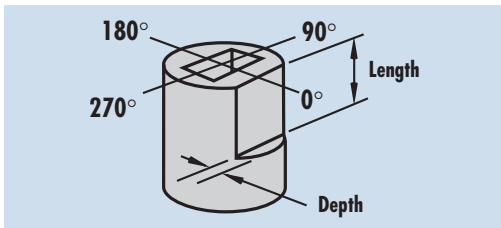

Additional Flats

Code	Depth	Length	Code	Depth	Length
X81	1.5	13	X91	1.5	13
X82	1.5	16	X92	1.5	16
X83	1.5	20	X93	1.5	20
X84	1.5	Full Length	X94	1.5	Full Length
X85	2.5	13	X95	2.5	13
X86	2.5	16	X96	2.5	16
X87	2.5	20	X97	2.5	20
X88	2.5	Full Length	X98	2.5	Full Length
X89	Specify Dimensions		X99	Specify Dimensions	

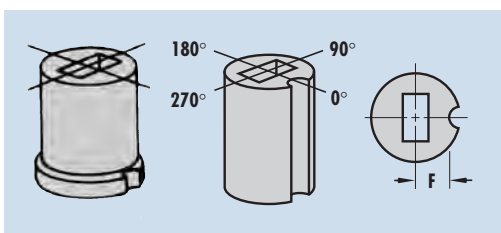

Dowel Slots

Locking Devices: Dowel Ø	Dowel Slots X0, X4, X41, X43				Dowel Slots X1, X7, X71, X73			
	X0	X4	X41	X43	X0	X4	X41	X43
	3.0	3.0	4.0	6.0	3.0	3.0	4.0	6.0

How to order:

X0 – 180°

X71 – 135°

F Dimension for die buttons

Body Ø		08	10	13	16-25	32-100
X0/X1	F	0.5D	0.5D	0.5D	0.5D	0.5D
X4/X7	F	4.7	5.5	6.7	0.5D	0.5D
X41/X71	F	5.2	6.0	7.2	0.5D	0.5D
X43/X73	F	6.2	7.0	8.2	0.5D+1.0	0.5D

How to order:

5 ADO 40 30 P16.00 W6.40 X2
9 ADR 100 35 P75.00 W50.00 X83
6 ANK 50 40 P27.00 W19.00 X43

Key Flats vs. Dowel Slots

maximum hole dimensions in die buttons were designed with key flats in mind. There are instances where, if using a dowel slot, the dowel hole could break into the relief. For this reason there are two ways to specify the location of the dowel. X0 (standard/alternate location) and X1 (custom location) are located .5D from centerline. However, when hole dimensions are approaching the high limit of "P" X4 (standard/alternate location) or X7 (custom location) may be specified. This relocates the dowel outward to assure no interference between the dowel and relief. Note, when the die button diameter is 16-71 the centerline dimension is 0.5D on all dowels.

LOCKING DEVICES FOR DIE BUTTONS TYPE DR_ AND DN_

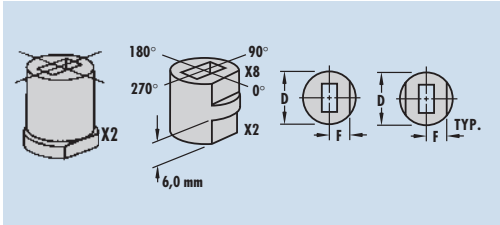

Flats

Locking Devices: Die button	Single Flats X2 and X8		Single Flats X5 and X9	
	X2 Bottom	X8 Top	X5 Bottom	X9 Top

How to order:

X2 – 90°

X5 – 135°

Locking Devices: Die button	Double Flats X3		Double Flats X6	
	X3 Bottom		X6 Bottom	

How to order:

X3 – 90°

X6 – 135°

Second Flat is always parallel to the first flat.

Die button

Body Ø	05	06	08	10	13	16	20	22	25
F	2.2	2.6	3.5	4.3	5.6	6.9	8.7	9.5	10.8
Body Ø	32	38	40	45	50	56	63	71	
F	13.8	16.8	17.4	19.5	21.7	24.2	27.3	30.7	

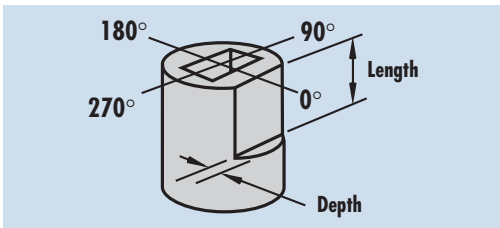

Additional Flats

Code	Depth	Length	Code	Depth	Length
X81	1.5	13	X91	1.5	13
X82	1.5	16	X92	1.5	16
X83	1.5	20	X93	1.5	20
X84	1.5	Full Length	X94	1.5	Full Length
X85	2.5	13	X95	2.5	13
X86	2.5	16	X96	2.5	16
X87	2.5	20	X97	2.5	20
X88	2.5	Full Length	X98	2.5	Full Length
X89	Specify Dimensions		X99	Specify Dimensions	

Dowel Slots

Locking Devices: Dowel Ø	Dowel Slots X0, X4, X41, X43				Dowel Slots X1, X7, X71, X73			
	X0	X4	X41	X43	X0	X4	X41	X43
	3.0	3.0	4.0	6.0	3.0	3.0	4.0	6.0

How to order:

X0 – 180°

X71 – 135°

F Dimension for die buttons

Body Ø	05	06	08	10	13	16-25	32-71
X0/X1 F	0.5D	0.5D	0.5D	0.5D	0.5D	0.5D	0.5D
X4/X7 F	3.5	3.9	4.7	5.5	6.7	0.5D	0.5D
X41/X71 F	4.0	4.4	5.2	6.0	7.2	0.5D	0.5D
X43/X73 F	5.0	5.4	6.2	7.0	8.2	0.5D+1.0	0.5D

How to order:

**5 DRO 40 30 P16.00 W6.40 X2
9 DRR 100 35 P75.00 W50.00 X83**

Key Flats vs. Dowel Slots

maximum hole dimensions in die buttons were designed with key flats in mind. There are instances where, if using a dowel slot, the dowel hole could break into the relief. For this reason there are two ways to specify the location of the dowel. X0 (standard/alternate location) and X1 (custom location) are located. 5D from centerline. However, when hole dimensions are approaching the high limit of "P" X4 (standard/alternate location) or X7 (custom location) may be specified. This relocates the dowel outward to assure no interference between the dowel and relief. Note, when the die button diameter is 16-71 the centerline dimension is 0.5D on all dowels.

CLASSIFIED SHAPES

Orientation & Locking

X2 Standard Locations

The standard location of key flats is at 0°. Alternate locations of 90°, 180° or 270° can be specified at no extra cost (against clockwise). Additional information on page 2.1.1 and 2.1.2.

X5 Alternate Locations

Custom locations of key flats can be specified as X5 and degree from 0°. The specification of the degree number is against clockwise.

Simplified Specifications

83 Common Shapes – No Detailing Required

90°

Flatted Rounds

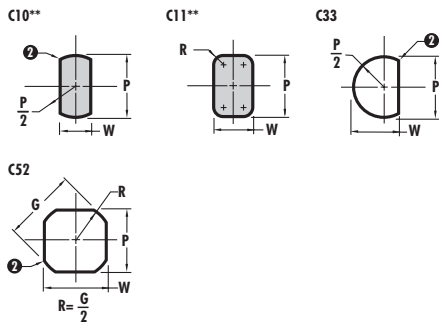

Mono Lobes

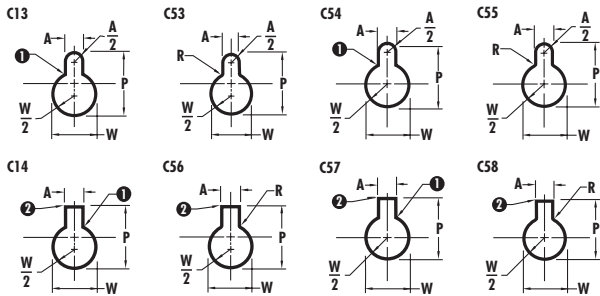

Miscellaneous

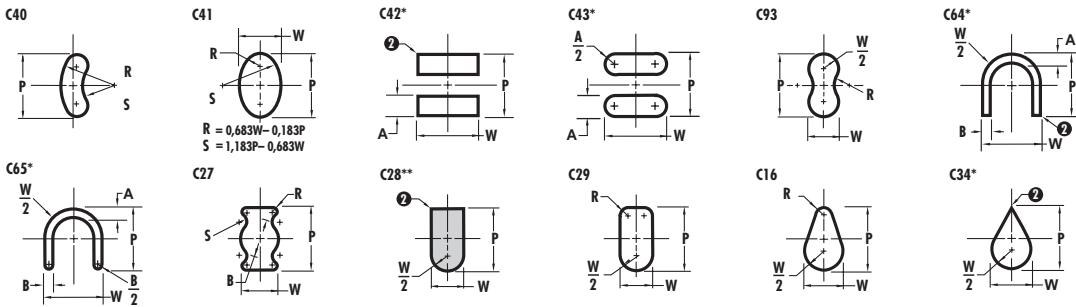

180°

0°

Triangles/Trapezoids

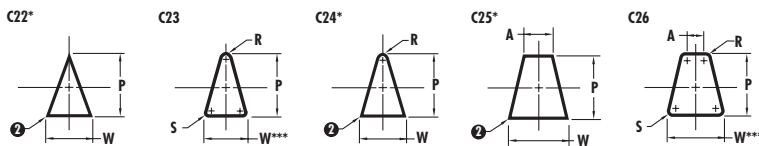

** Now a standard shape.

*** Tangential

Polygons

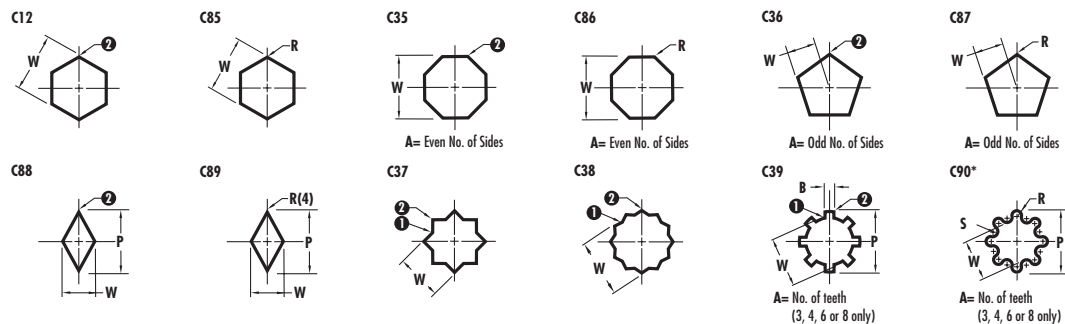

270°

Keys

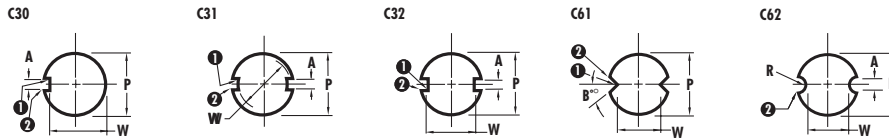

Multi Lobes

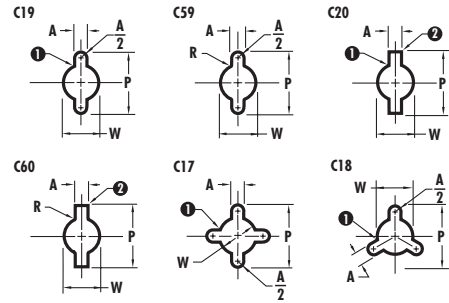

Duo Tees

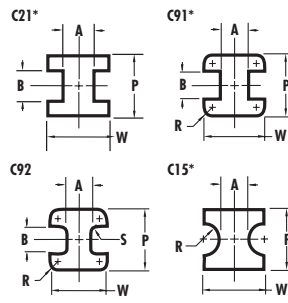

T's

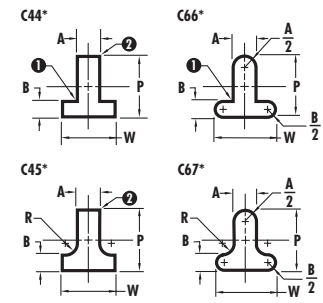

L's

180°

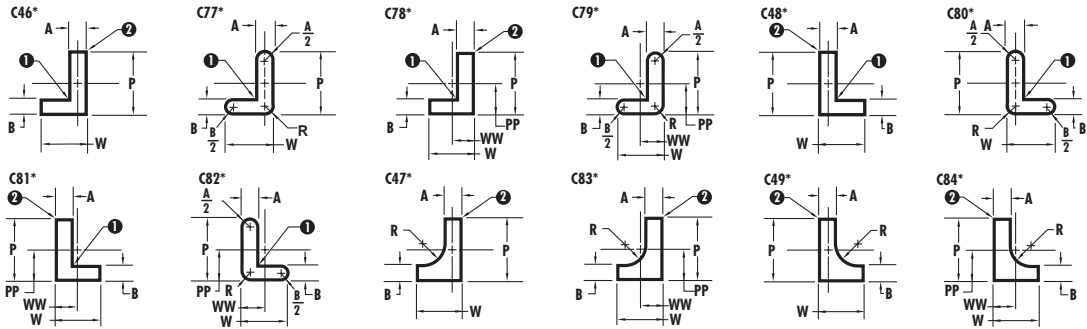

0°

U's

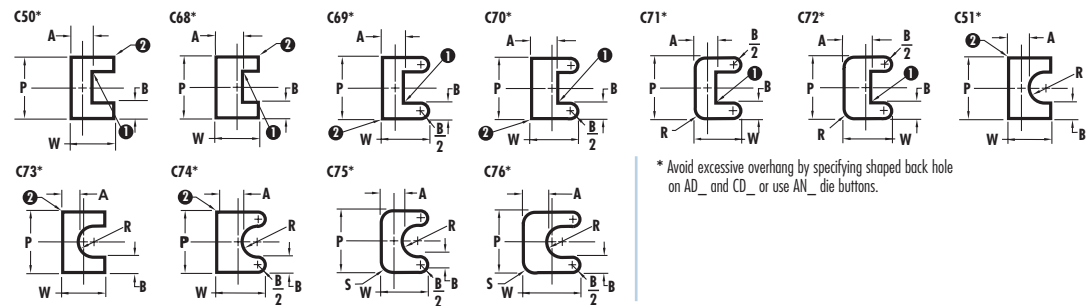

* Avoid excessive overhang by specifying shaped back hole on AD_ and CD_ or use AN_ die buttons.

1 Sharp corners are typical. To assure proper clearance, Dayton will provide standard broken corners if die button is ordered with punch to eliminate interference with die button fillet when total clearance is 0.08 or less.

2 Check your P&W dimensions to be sure the diagonal G does not exceed the max. shown. If G exceeds the max.

$$G = \sqrt{P^2 + W^2}$$

How to order:

Specify: Quantity
Type
Body Diameter
Point & Overall Length
Steel
Standard Alterations
P or P&W Dimensions

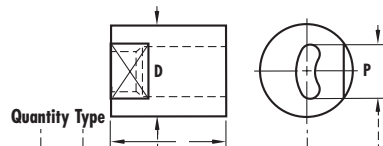

Quantity Type 10 ADC 38 S32 C40 P16.1 R35.1 S28.1 X80

